

Model / HD2-010

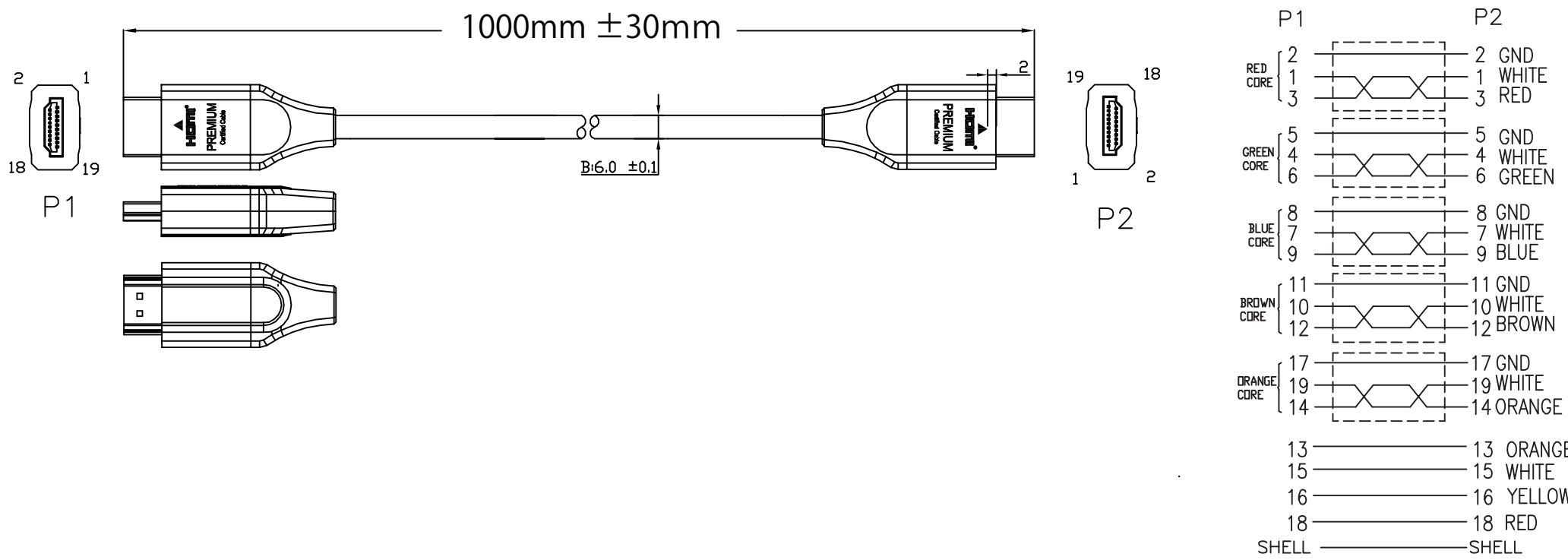

A&M Co., Ltd.

3	OUTER JACKET PVC 45Pa BLACK(1101) RoHS
2	HDMI A/M @ (A B C D & E F G H W / I J E (G K) L M N ROHS
1	UL20276 (30#2C+1C+AM)4+(30#1P+DAM)+30#4C+FAB OD:6.0 BLACK(1101)1000MM W/PREMIUM !

DRAW. NO		DESC.	HDMI A/M TO A/M CABLE ASS'Y		
DEPARTMENT	RD	DRAW	DAT	2017.5.01	
SCALE	NONE	CHECK	DATE		
UNIT	mm	APPROVED	SHEET	1 OF 1	

Material		Part Number		Note	***	3RD		
----------	--	-------------	--	------	-----	-----	--	--